



VECTRON® WAVE

INSTRUCTION GUIDE

8-10 YRS

The Air Hogs® Vectron® Wave is perfect for first-time flyers. All you need is an open space and 6 x 1.5-V AA alkaline batteries (not included) to take flight. Some assembly required. ADULT SUPERVISION RECOMMENDED. PLEASE READ THESE INSTRUCTIONS BEFORE FLYING!

Contents:

- 1 Air Hogs® Vectron® Wave
- 2 Catching Sticks
- 1 Charger
- 1 Instruction Guide

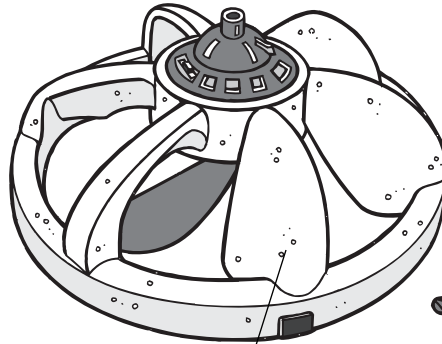

Vectron® Wave

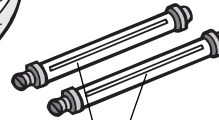

Catching Sticks

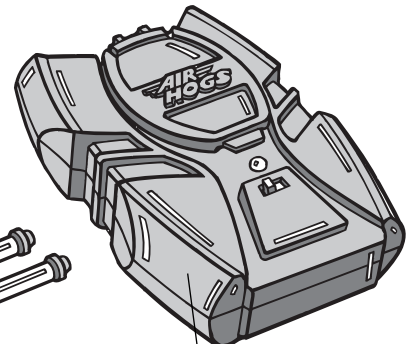

Charger



WARNING:
CHOKING HAZARD – Small parts.
Not for Children under 3 years.

BATTERY REMOVAL AND INSTALLATION

1. Open the battery door with a screwdriver.
2. If used batteries are present, remove these batteries from the unit by pulling up on one end of each battery.
3. Install new batteries as shown in the polarity diagram (+/-) inside the battery compartment.
4. Replace battery door securely.
5. Check your local laws and regulations for correct recycling and/or battery disposal.

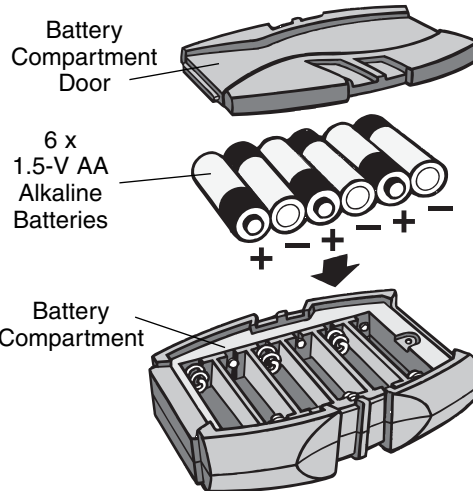

NOTE: Attach the catching stick to the Vectron® Wave by pushing the bottom of the stick into the hole on the top of the Vectron® Wave. Use catching stick to toss or catch the Vectron® Wave.

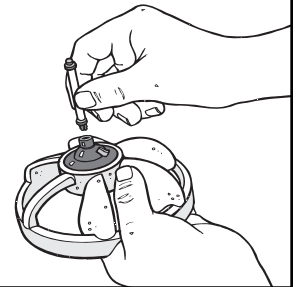

GETTING TO KNOW YOUR VECTRON® WAVE

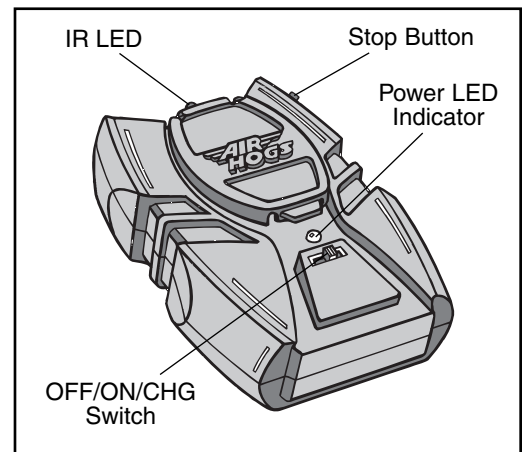
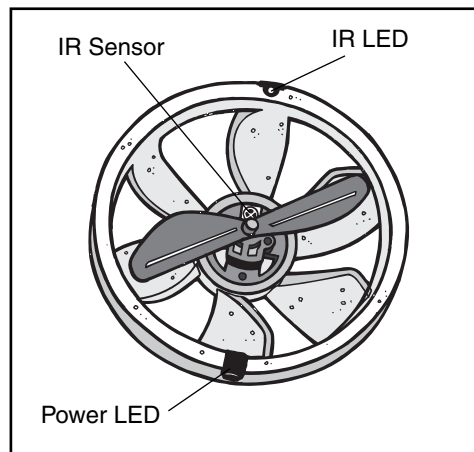
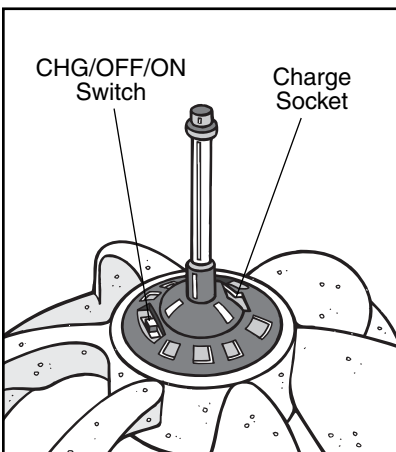

INDOOR USE ONLY

1. Fly in a wide-open room, away from breakable items. Minimum size 4 m wide x 4 m long x 3 m high.
2. Avoid flying near vents and/or fans, as these may overpower the Vectron® Wave and make it difficult to control.
3. Sunlight or bright lights may affect your Vectron® Wave's performance.
4. Avoid flying near another IR device. This may affect your Vectron® Wave's performance as well.

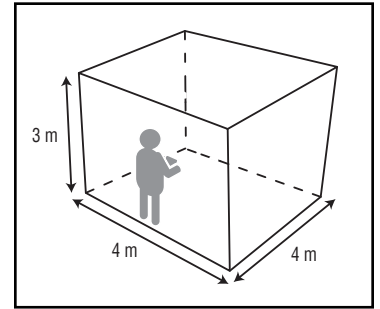
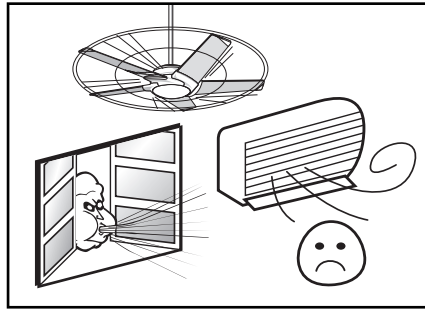

NOTE: Always get permission to fly your Vectron® Wave indoors.

⚠ CAUTION: Never fly near your face. Keep rotor away from your fingers, hair, eyes and other body parts. Always lift off from a flat surface. Never hold the Vectron®

Wave in your hand when lifting off. **DO NOT** launch Vectron® Wave near people or animals. Stay away from obstacles and electrical hazards.

CHARGING YOUR VECTRON® WAVE

1. Open door in charger to access the charge cable.
2. Plug charge cable into the charge port on Vectron® Wave.
3. Set switch on Vectron® Wave to charge.
4. Set switch on charger to charge. The Power LED Indicator on the charger will turn red and flash. When the Vectron® Wave is fully charged the Power LED Indicator will turn orange. This may take up to 30 minutes or longer if the Vectron® Wave is fully discharged and the charger batteries are not new.

NOTE: For better flight performance, fully charge your Vectron® Wave before each flight.

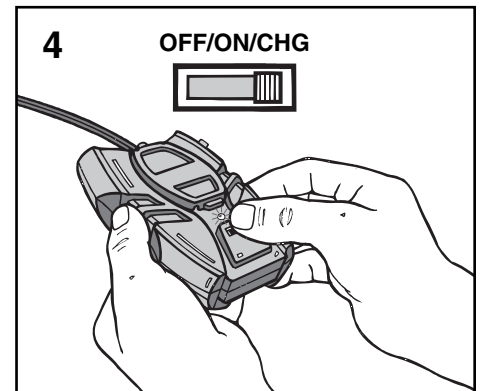
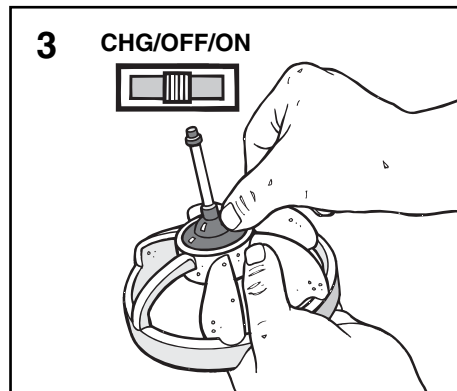
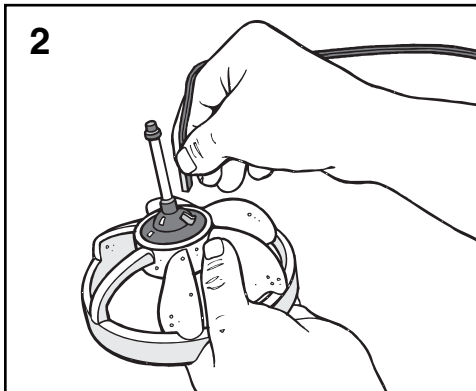
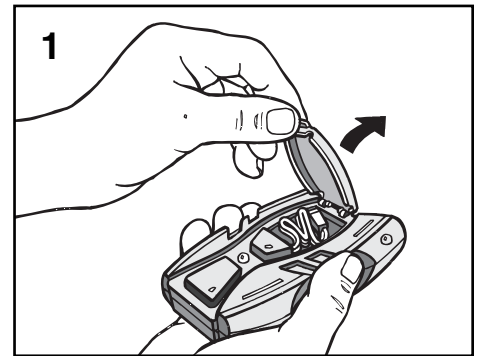

AFTER CHARGING IS OVER

1. Set switch on charger to "OFF".

2. Remove charge cable from Vectron® Wave and store in charger.

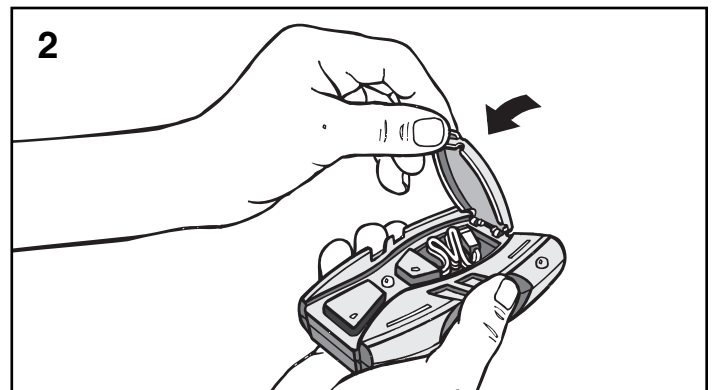
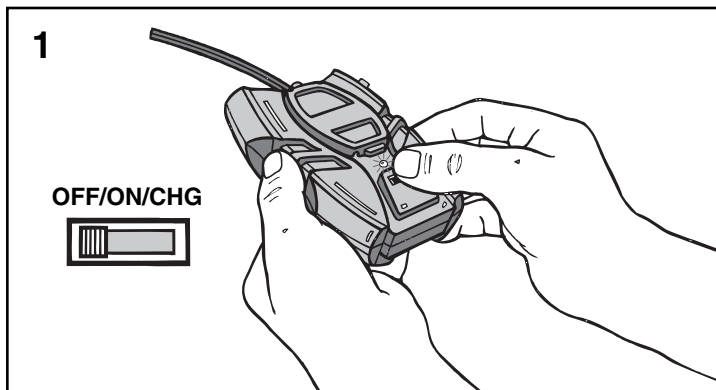

HOW TO USE YOUR VECTRON® WAVE

1. Turn your Vectron® Wave “ON”. After a few seconds the propeller will begin to spin.

⚠ **CAUTION:** Rotating propellers, please use care when handling.

2. Set your Vectron® Wave on a flat surface or the ground.
NOTE: Your Vectron® Wave will go through a “**Start-Up Process**” at this point. First it will rise up, then it will slowly fall, then it will rise up again. This helps it to memorize the power required to hover on its’ own. After it rises the second time the process is over and you can begin to play. **NOTE:** During this process do not touch or play with your Vectron® Wave as this will make its’ hovering ability unstable.

3. **Hand Play:** The Vectron® Wave will hover above your out-stretched hand.

4. **Sliding or Tossing:** Hold the Vectron® Wave by the catching stick and tip forward 10-30°. Toss or slide gently to another player.

5. When finished playing press the stop button on the charger to turn the propeller “OFF” then turn the power switch on the Vectron® Wave to “OFF”.

NOTE: If the Vectron® Wave tips over or sticks to the ceiling, use the STOP button on the charger to stop the propeller. After pressing the stop button on the charger, the Vectron® Wave will slow down and settle to the ground.

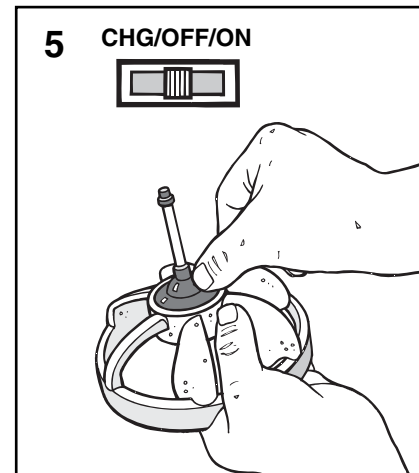
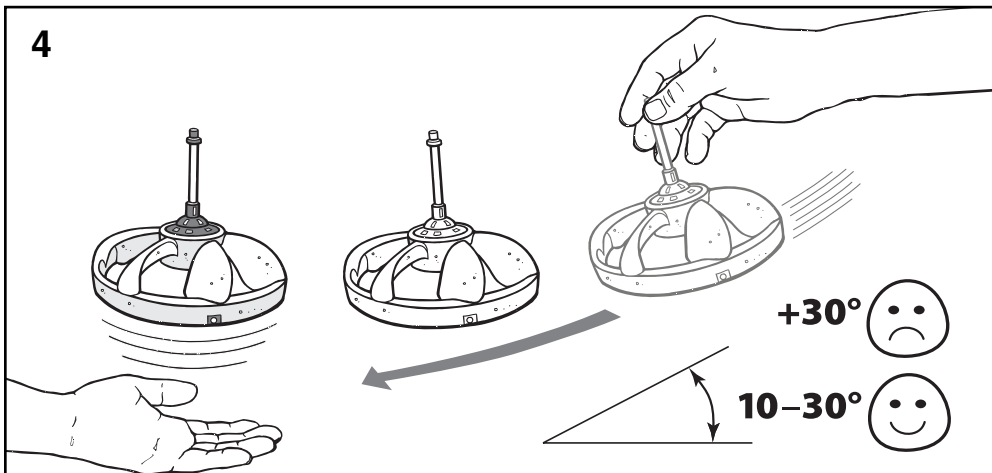
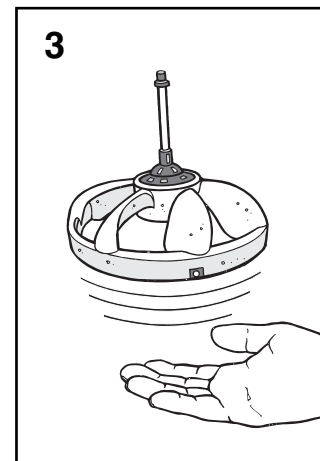
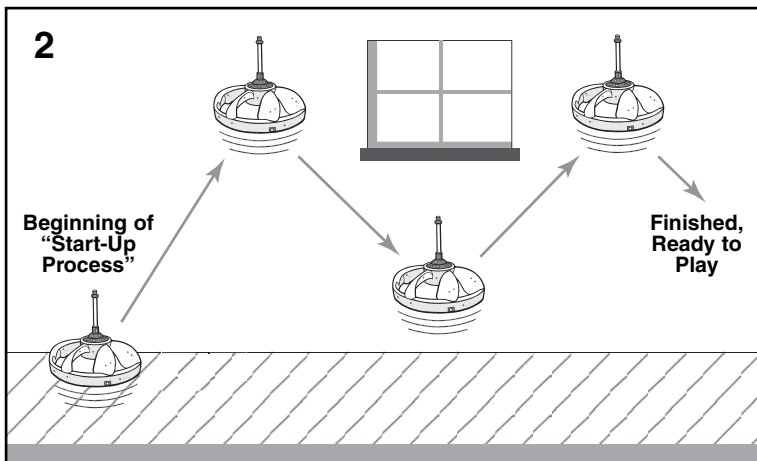
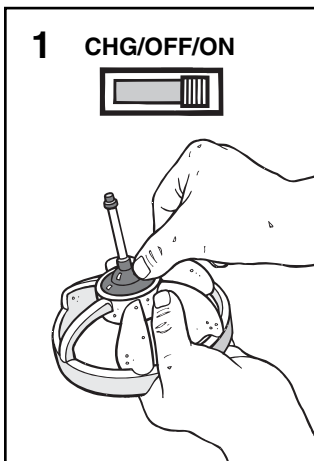

TROUBLESHOOTING

PROBLEM	CAUSE	SOLUTION
Charger LED is OFF (not flashing).	1. Charger may be in sleep mode (enters sleep mode after about 2 minutes of inactivity). 2. The batteries in the charger are drained.	1. Turn charger OFF then ON again. 2. Install new batteries in charger.
Stop button is not working.	1. Vectron® Wave is out of range. 2. Charger is in sleep mode.	1. Move charger closer to the Vectron® Wave. 2. Turn charger OFF then ON again or press stop button again.
Charger LED is flashing Red/Green alternatively while charging Vectron® Wave.	Error while charging.	Check that the connection between the charger and the Vectron® Wave is not broken, if it is, reconnect it.

TROUBLESHOOTING cont'd...

PROBLEM	CAUSE	SOLUTION
Charger LED is flashing Green.	Batteries in charger are low.	Install new batteries in charger.
Vectron® Wave will not start or has lost power.	<ol style="list-style-type: none"> You have not set the motor switch to "ON". Charger battery power is low. Batteries (+) or (-) are not correctly placed inside the battery compartment. Vectron® Wave battery is low. 	<ol style="list-style-type: none"> Slide motor switch to "ON". Replace the charger batteries. Be sure to align the (+) and (-) polarities with the corresponding markings inside the battery compartment. Recharge Vectron® Wave.
Vectron® Wave is flying too low.	<ol style="list-style-type: none"> The batteries in the charger are drained. Vectron® Wave's battery is low. Hair or debris may be caught in the rotor. 	<ol style="list-style-type: none"> Install new batteries in charger. Recharge Vectron® Wave. Remove hair or debris.
<p>NOTE: If normal function of the product is disturbed or interrupted, strong electro-magnetic interference may be causing the issue. To reset product, turn it completely off, then turn it back on. If normal operation does not</p>		<p>resume, move the product to another location and try again. To ensure normal performance, change the batteries, as low batteries may not allow full function.</p>

IMPORTANT BATTERY INFORMATION

- Requires 6 x 1.5-V AA alkaline batteries (not included).
- Batteries are small objects.
- Replacement of batteries must be done by adults.
- Follow the polarity (+/-) diagram in the battery compartment.
- Promptly remove dead batteries from the toy.
- Dispose of used batteries properly.
- Remove batteries for prolonged storage
- DO NOT incinerate used batteries.

- DO NOT dispose of batteries in fire, as batteries may explode or leak.
- DO NOT mix old and new batteries or types of batteries (i.e. alkaline/standard).
- DO NOT use rechargeable batteries.
- DO NOT recharge non-rechargeable batteries.
- DO NOT short-circuit the supply terminals.

Your Vectron® Wave is equipped with a Lithium Polymer battery.

SPECIAL LiPO BATTERY INSTRUCTIONS:

- Never charge battery unattended.
- Charge battery in isolated area. Keep away from flammable materials.
- Do not expose to direct sunlight.
- There is a risk of the batteries exploding, overheating, or igniting. Do not disassemble, modify heat, or short circuit the batteries. Do not place them in fires or leave them in hot places.

- Do not drop or subject to strong impacts.
- Do not allow the batteries to get wet.
- Only charge the batteries with the specified Spin Master™ battery charger.
- Only use the batteries in the device specified by Spin Master™.
- Carefully read the instruction guide, and use the batteries correctly.
- In the unlikely event of leakage or explosion use sand or a chemical fire extinguisher for the battery.
- Batteries must be recycled or disposed of properly.

PRODUCT BATTERY REMOVAL INSTRUCTIONS:

Internal battery is factory installed, product disassembly and battery removal must be performed by an adult. Do not use any tools for disassembly. Pulling, tearing, and deforming of the product during disassembly, while necessary, should be as limited as possible. Do not compress the product at any time. Ensure product is turned off. Find a point where the two body halves meet; the nose of the aircraft or where the wing meets the body. Start to peel the halves apart, separating them where they are

glued together; remove any tape as necessary. Separate product body halves to expose internal electronics. To separate battery from product use scissors to cut a single battery wire, immediately wrap the cut wire end with tape to isolate it, repeat until all battery wires are cut and isolated. Dispose of battery in accordance with your local battery recycling or disposal laws. **NOTE:** Opening of product and/or removal of battery will render product inoperative and voids manufacturer warranties, dispose of remaining product components in accordance with local laws.

Imported by:
SPIN MASTER INTERNATIONAL, S.A.R.L., 16 AVENUE PASTEUR, L-2310, LUXEMBOURG
www.spinmaster.com

Air Hogs® is a registered trademark of Spin Master Ltd. and Vectron® is a registered trademark of Steven Davis. © 2011 Spin Master Ltd. All rights reserved. • Please retain this information for future reference. • Please remove all packaging materials before giving to children. • An adult should periodically check this toy to ensure no damage or hazards are found, if so, remove from use. • Children should be supervised during play. • Keep addresses and phone numbers for future reference. • The item inside this package may vary from the photographs and/or illustrations. This product conforms to safety requirements of EN71. MADE IN CHINA.

20043842, 20043843 EML English REV 0
T44363_0109_20043842_EML_IS_R1

20051555, 20051556 EML English REV 0
T44363_0118_20051555_EML_IS_R1

 Contains 1 LiPo battery pack. • Battery pack must be recycled or disposed of properly. • If at any time in the future you should need to dispose of this product please note that Waste Electrical Products should NOT be disposed of with household waste. Please recycle where facilities exist. Check with your Local Authority or retailer for recycling advice. (Waste Electrical and Electronic Equipment Directive).



Warning:
CHOKING HAZARD –
Small Parts.

